

标记(mark)	修改内容(revised contents)	签名(signature)	日期(Date)
<1>			
<2>			

Front view

Side view

Back view

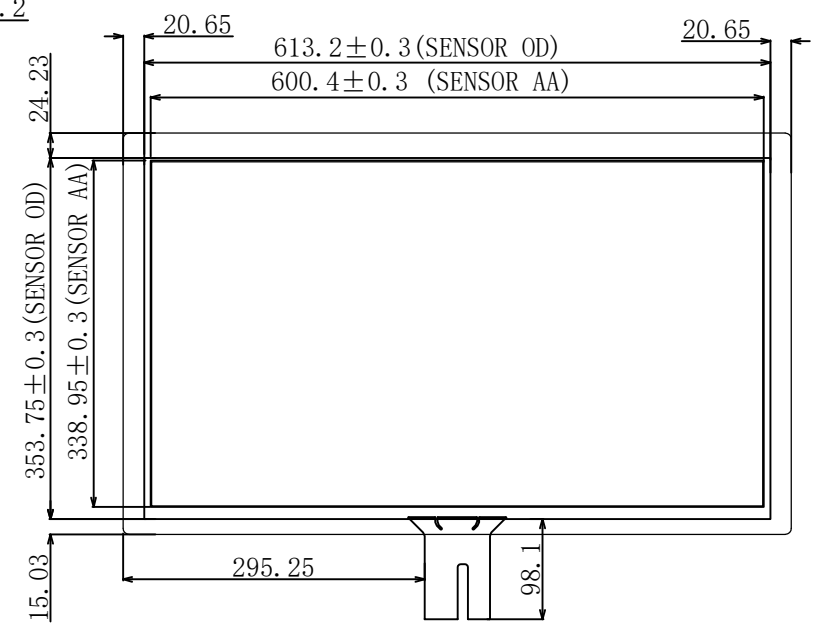
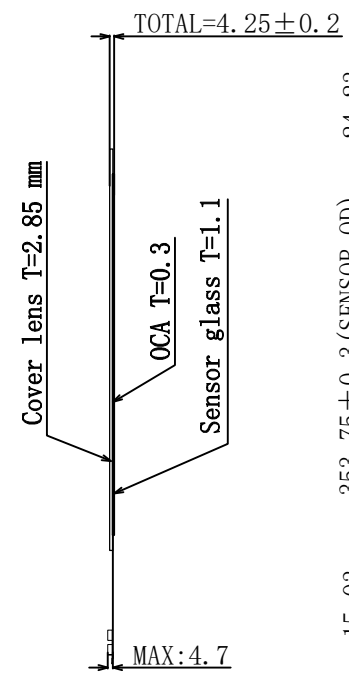
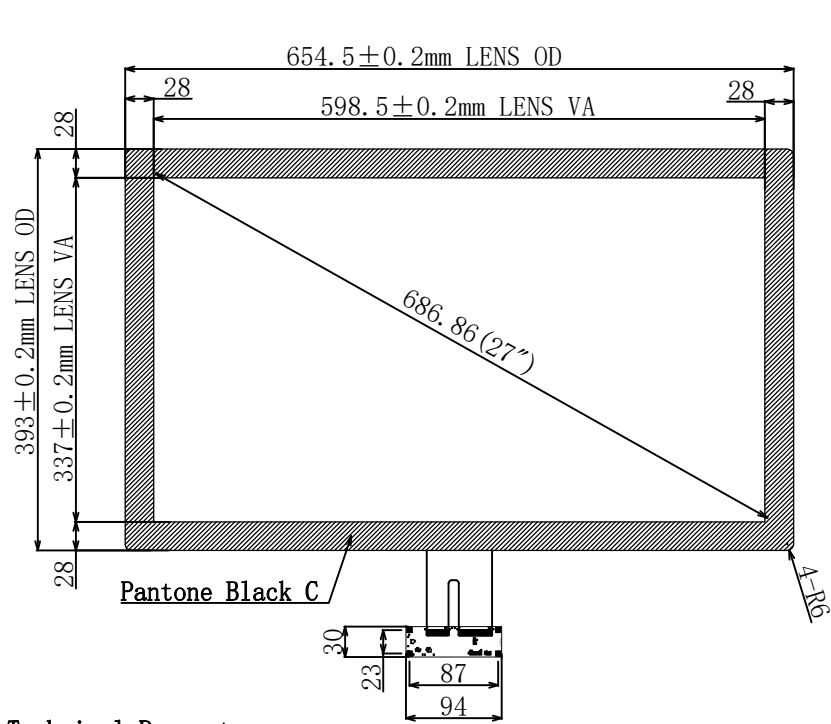

- Technical Parameters**
- 0: Interface :USB, ILI2510
 - 1: Touch point: 10
 - 2: Cover lens + Sensor glass + OCA + FPC
 - 3: Cover lens Thickness = 2.85 mm
 - 4: Sensor glass Thickness = 1.1mm
 - 5: OCA Thickness = 0.3mm
 - 6: Total Thickness = 4.25mm
 - 7: Sensor Process: Print Process (ITO Pattern) + laser line (Ag)
 - 8: Input Voltage 3.5V~5.5V, Typical 5V
 - 9: Transmittance: >85%
 - 10: Surface Hardness: >6H
 - 11: Relative Humidity: 95% at 60°C, RH Non-condensing
 - 12: Operating Conditions: -10 to 70 °C
 - 13: Storage Conditions: -20 to 70 °C
 - 14: Dimension tolerance: ±0.3mm

东莞市越丰光电有限公司 Dongguan Yuefeng Photoelectric Co., Ltd				
TITLE: 产品编号		YFDR0270122		
Designed By: 设计	Customerid: 客户编号		View: 投影方式	
Checked By: 审核	Unit: 单位	mm		
Approved By: 批准	Date: 日期	20191212	Scale: 比例	1:1

由 Autodesk 教育版产品制作

由 Autodesk 教育版产品制作